

39223 (140-SP) Rivet Nut setting Tool (Spin /Pull)



This spin-pull tool automatically threads the fastener onto the mandrel. Press the trigger just once and the fastener is installed. Reverse the trigger and the mandrel spins out of the fastener. The 39223 features a totally adjustable stroke length to suit any grip range and a swivel air inlet for increased mobility. No complicated tear down is required to adjust the stroke or to change thread sizes...both adjustments are done outside the tool. The 39223 handles rivet-nut sizes 6-32" through 1/4-20" Mandrels and nosepieces are available for 4,5 and 6mm.

Weight: 4.9 lbs.



**Arconic
Fastening
Systems and Rings**

1925 N MacArthur Dr.
Suite 200
Tracy, CA 95376

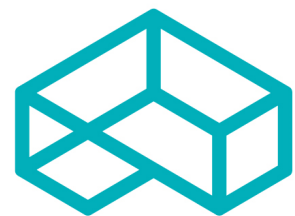

ARCONIC

Air Feed

Use only compressed air. Check airline for damage from humidity & contaminants. In order to protect the tool from premature wear, we recommend the use of an in line moisture filter and air regulator.

Air inlet thread connection size on the tool is ¼" NPT.

WARNING: Do not use air supply greater than recommended or tool may be damaged or burst. Do not use oxygen, combustible gases or bottled gases as a source for this tool. Gases could cause the tool to explode.

CAUTION:

ALWAYS WEAR SAFETY GLASSES WHEN OPERATING

Main Components

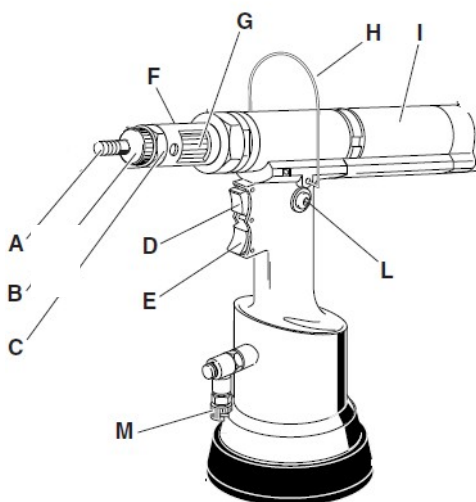

- A: Mandrel
- B: Nosepiece
- C: Nosepiece Lock Nut
- D: Trigger
- E: Trigger Reverse
- F: Insertion Pin Hole
- G: Stroke Adjustment
- H: Balancer Connection
- I: Motor
- L: Fluid Plug
- M: Air Connection (1/4-20 NPT)

MAINTENANCE

ADDITION OF HYDRAULIC FLUID

The Hydraulic oil should be topped off after a long period of usage or when there is a power loss of the tool. Put the tool in a vertical position rotating the knob (G) towards the plus sign + up to the end of the stroke, and remove plug (L) by using a 4mm Allen wrench (supplied). After removal of plug (L) check the oil level in order to avoid overflowing. Next screw the oil container supplied into the oil inlet hole until it is seated. While keeping the tool in the vertical position connect the air line and push button (D) and then cycle the tool several times until air bubbles in the oil container stop appearing in the oil container. This indicates that tool is filled of oil and is ready for use. Disconnect the air line and unscrew the oil container from tool and replace plug (L) first checking to be sure the washer on plug is in position and not damaged.

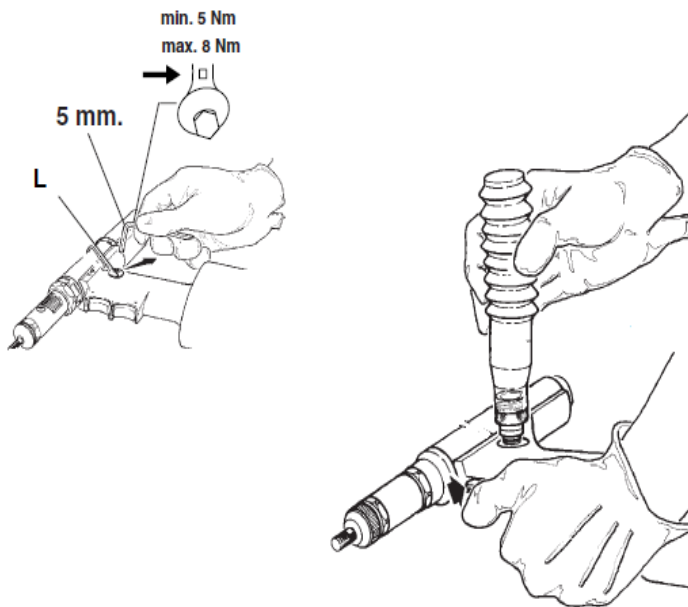

IMPORTANT: Make sure plug (L) is tightened at a torque corresponding to min. of 3.6 ft-lb and a max. Of 5.9 ft-l

Changing Mandrel and Nosepiece

WARNING! DISCONNECT AIR FEED WHEN PERFORMING THIS OPERATION

The tool is supplied with mandrels (A) and nosepieces (B) for setting Rivet Nuts. Depending on the Rivet-Nut thread size it may be necessary to change mandrel (A) and nosepiece (B). This can be done by loosening the nosepiece lock nut (C) using a 25mm wrench and then remove nosepiece. (Pic. 1)

Using the pin supplied pass it through the service hole (Pic. 2) pull back on the head towards the back of the tool and hold it there in order to release the mandrel clutch and at the same time unscrew the mandrel and remove it. While continuing to hold the pin back screw in the selected size mandrel. When the replacement of the mandrel has been completed, swing it until you hear a click. (Pic. 3) Then assemble the proper nosepiece and lock it with the lock nut. (Pic. 4)

1

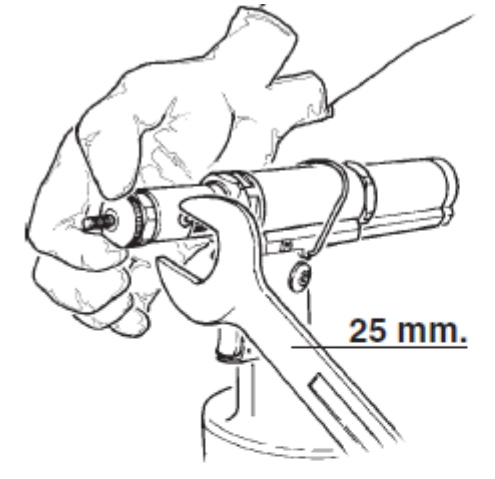

2

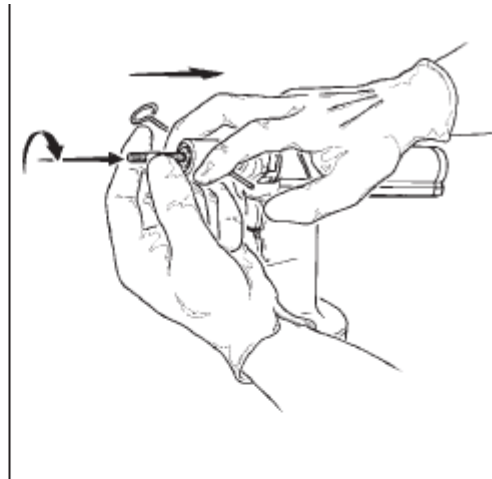

3

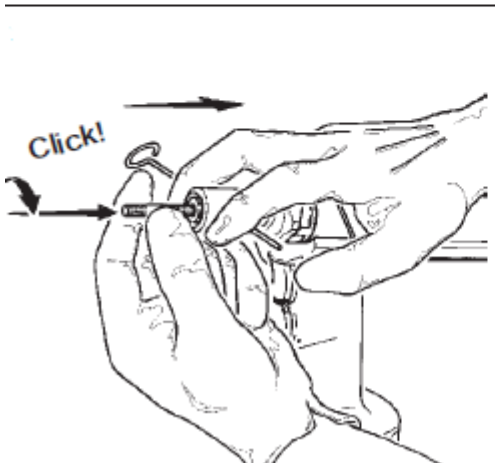

4

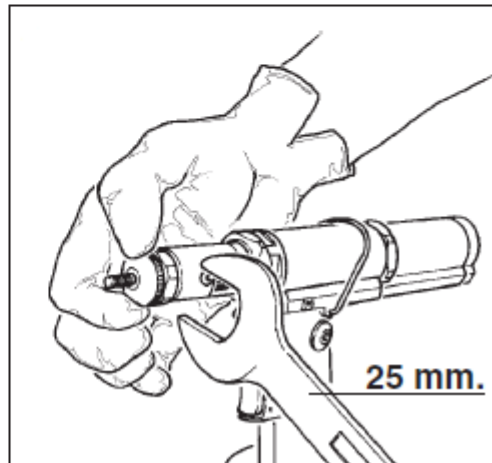

Adjusting Stroke Length (Preliminary Operations)

Before using the tool and after each change of thread size, the stroke should be adjusted according to the dimensions, type of insert and thickness of material rivet nut is to be installed in. Before setting rotation of knob (G) in the direction indicated either decreases (-) or increases (+) the clamping force (h).

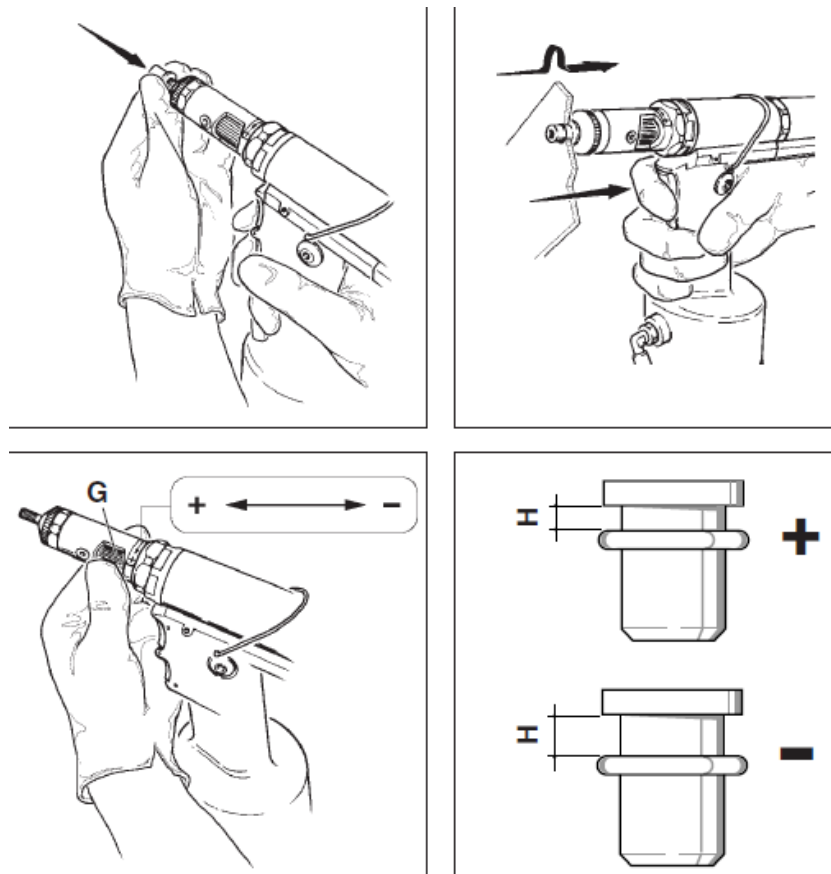

3 Simple steps to set Rivet-Nut

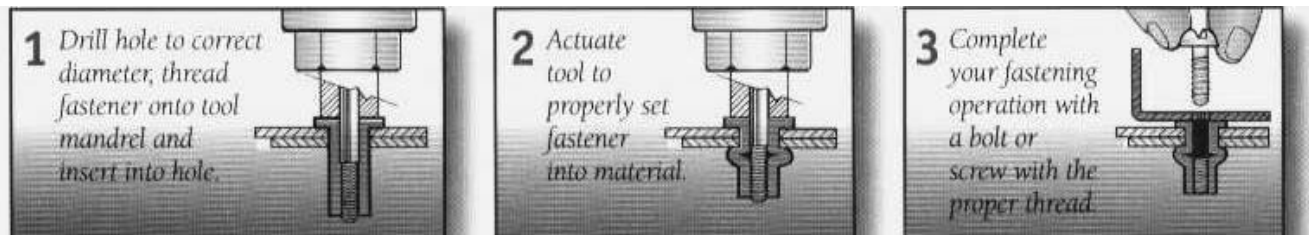

Tool Break Down & Parts List

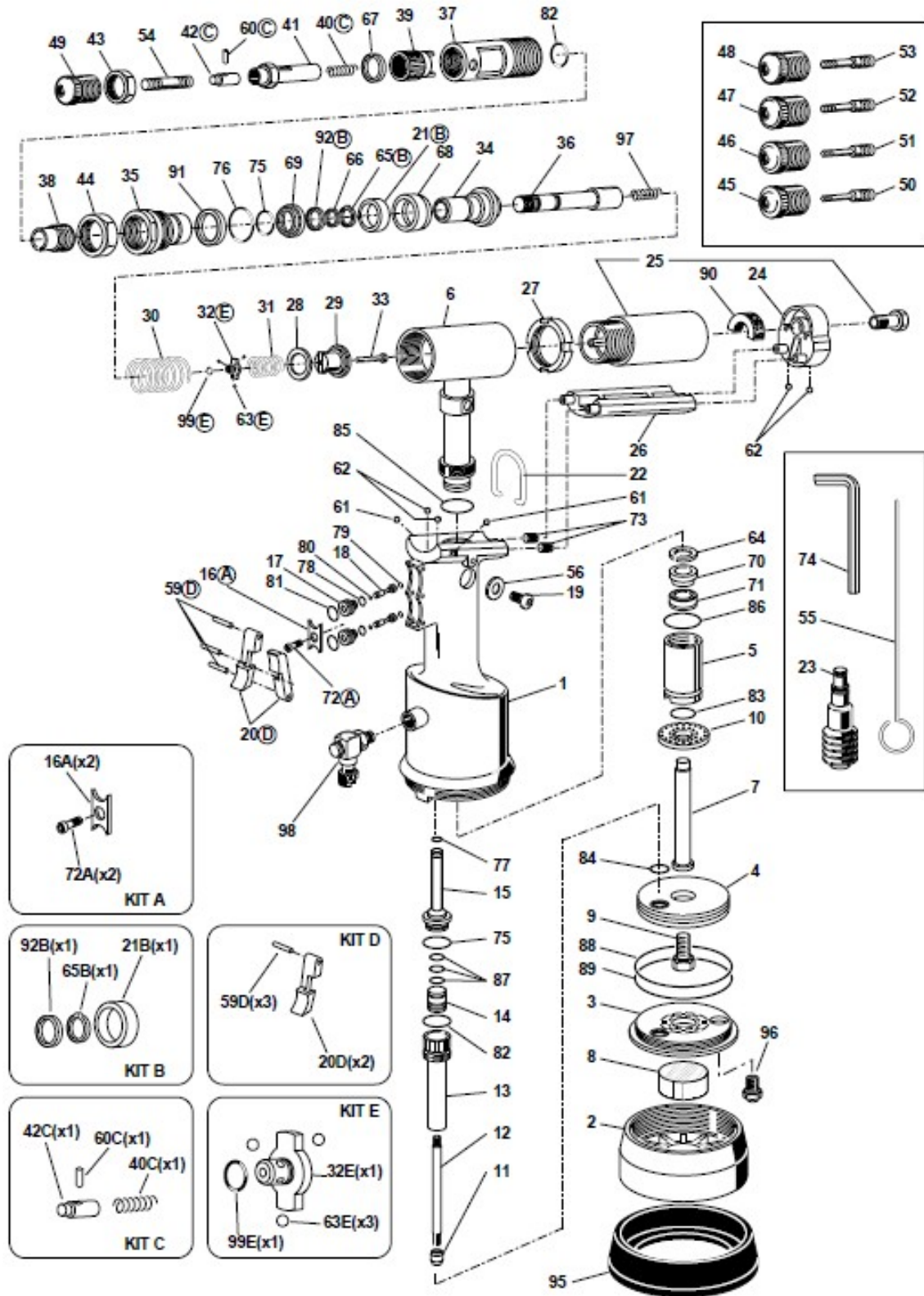

Ref. No.	Marson #	Description	Qty/Tool
1	88601	Tool Body	1
2	88602	Body cover	1
4	88604	Pneumatic Piston	1
5	88605	Connector	1
7	88607	Stem	1
8	88608	Silencer	1
10	88610	Dampener	1
11	88611	Lower Coil	1
13	88613	Valve Body	1
15	88615	Upper Valve Body	1
16A	see below	Plate	1
18	88618	Valve Piston	2
19	88035	Fluid Plug	1
20D	see below	Push Button	2
21B	see below	Spacer	1
22	88065	Balancer Connection	1
23	88084	Oil Container	1
24	88624	Motor cover	1
25	88625	Motor SP 237	1
26	88626	Motor Protection Sector	1
27	88627	Ring Nut for Motor	1
28	88628	Stop Ring	1
29	88629	Clutch	1
30	88630	Piston Return Spring	1
31	88631	Ball Locking Spring	1
32E	see below	Ball Bushing	1
33	88633	Rod	1
34	88634	Oleo dynamic Piston	1
35	88635	Front Connector	1
36	88636	Shaft	1
37	88637	Milled Sleeve	1
38	88638	Stroke Adjusting Nut	1
39	88639	Stroke Adjusting Knob	1
40C	see below	Mandrel Spring Disengagement	1
41	88641	Mandrel Carrying Head	1
42C	see below	Mandrel Clutch	1
43	88643	Head Ring Nut	1
44	88644	Ring Nut	1
55	88219	Mandrel Adapter	1
56	88034	Plug Washer	1
59D	see below	Pin 2 X 20 UNI 1707	3
60C	see below	Spring Pin 4 X 12	1
61	88661	Ball o 3.5	2
62	88662	Ball o 4	4
63E	see below	Ball o 2.5	3
64	88664	Seeger Ring I18	1
65B	see below	Seeger Ring E16	1
66	88666	Seeger Ring SW11 x 1	1
67	88667	Seeger Ring JV 20 x 1	1
68	88668	O' ring B-110078/B/NEO	1
69	88669	O' ring B-094063/B/NEI	1
70	88670	O' ring B-070039/1	1
71	88671	Gasket TS-10-18-5.8/L	1
72A	see below	Screw VSP-4x8 UNI 5933	1

73	88673	Inox Filter o 6 X 4	2
74	88220-76	Allen Key	1
75	88675	O' ring 2-16 P	2
76	88676	O' ring 2-119(N552790) P	1
77	88220-36	O' ring 2-8 P	1
78	88158	O' ring 2-9 P	2
79	88047	O' ring 2-5 P	2
80	88043	O' ring 2-4 P	2
81	88681	O' ring 5-052 P	2
82	88682	O' ring 2-17 P	1
83	88321	O' ring 2-12 P	1
84	88684	O' ring 5-614 P	1
85	88685	O' ring 2-18(N552790) P	1
86	88686	O' ring 2-118 P	1
87	88021	O' ring 5-612 P	3
88	88688	O' ring 2-232 P	1
89	88689	O' ring 2-40 P	1
90	88690	Silencer	1
91	711917	Parbak 8.119	1
92B	see below	Seeger Ring JV24	1
95	88695	Bottom Protector	1
96	88696	Safety Valve Assembly	1
97	88697	Rod Locking Spring	1
98	88698	Rotating Connector	1
99E	see below	O' ring 1x4	1
		ACCESSORIES	
		MANDREL SELECTION	
	88701	#6 Nosepiece	
	88702	#8 Nosepiece	
	88703	#10 Nosepiece	
	88704	1/4 Nosepiece	
	88708	6-32 mandrel	
	88709	8-32 mandrel	
	88710	10-24 mandrel	
	88711	10-32 mandrel	
	88712	1/4-20 mandrel	
		METRIC MANDREL SELECTION	
	88651	4mm Mandrel	
	88652	5mm Mandrel	
	88653	6mm Mandrel	
		NOSEPIECE SELECTION	
	88701	#6 Nosepiece	
	88702	#8 Nosepiece	
	88703	#10 Nosepiece	
	88704	1/4 Nosepiece	
		METRIC NOSEPIECE SELECTION	
	88646	M4 Nosepiece	
	88647	M5 Nosepiece	
	88648	M6 Nosepiece	

KIT"A"	741702	Plate Kit	
contains			
16A	88616	Plate	2
72A	88672	Screw VSP-4x8 UNI 5933	2
KIT"B"	741713	Spacer Kit	
contains			
21B	88621	Spacer	1
65B	88665	Seeger Ring E16	1
92B	88692	Seeger Ring JV24	1
KIT"C"	741802	Clutch for Tie Rod Kit	
contains			
40C	88640	Mandrel Spring Disengagement	1
42C	88642	Mandrel Clutch	1
60C	88660	Spring Pin 4 X 12	1
KIT"D"	741705	Push-button Kit	
contains			
20D	88620	Push Button	2
59D	88659	Pin 2 X 20 UNI 1707	3
KIT"E"	741792	Ball bushing Kit	
contains			
32E	88632	Ball Bushing	1
63E	88663	Ball o 2.5	3
99E	713341	O' ring 1x4	1



ARCONIC